

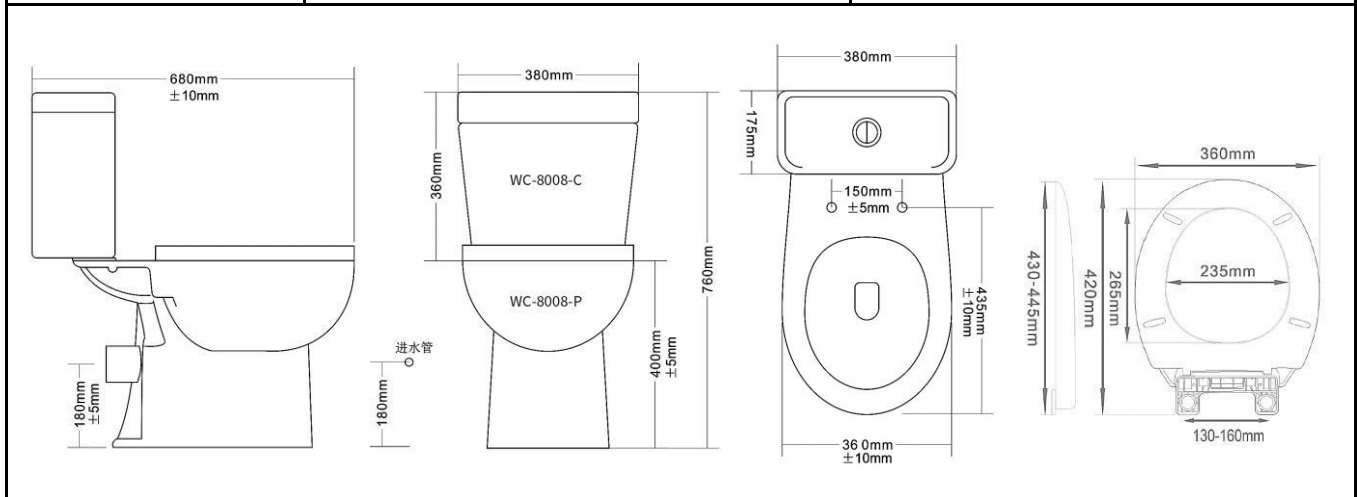

PROJECT		REF		REV	ITEM CODE	
LOCATION		DATE			PAGE	

SANITARY WARE SPECIFICATION SHEET

<p>Item Descriptions</p>	<p>Ansporn (PRC) Vitreous china close-coupled p-trap watercloset with plastic seat and cover; stainless steel in grade 304 fixing kits; nominated flow rate 3.2/5.4 L/flush in WELS Grade 2; Registration No. WC 21-0139</p>	<p style="text-align: center;">Illustration/ Drawing</p>
<p>Outlet</p>	<p>H.O. Trapway 180 mm</p>	
<p>Dimension</p>	<p>L680 x W380 x H760 mm</p>	
<p>Model</p>	<p>WC-8008</p>	
<p>Finish</p>	<p>White</p>	
<p>Material</p>	<p>Vitreous China / Stainless Steel 304 / Plastic</p>	
<p>Manufacturer</p>	<p>Ansporn (PRC)</p>	
<p>Source</p>	<p>Acme Sanitary Ware Co. Ltd Mr. Eric Wong/ Mr. Don Yuen</p>	
<p>Contact Tel/Fax</p>	<p>(852) 2388-7171 / (852) 2710-8012</p>	
<p>E-mail</p>	<p>acme@acmesanitary.com.hk</p>	
<p>Website</p>	<p>www.acmesanitary.com.hk</p>	



Note:

* All information of the above is for the reference only. No prior notice is made if any changes.



自願參與用水效益標籤計劃 - 水廁
Voluntary Water Efficiency Labelling Scheme - Water Closets



註冊證書

Registration

茲證明

This is to certify that

將下列水廁在本計劃內註冊：
has registered the following water closet under this scheme :

牌子 / Brand	: Ansporn + NUCA
型號 / Model	: WC-8008 + C211
種類 / Category	: Close-coupled Suite
原產地 / Country or Region Origin	: China (WC Pan & Cistern) China (Flushing Valve)

在用水效益標籤上展示的標誌 <i>Symbolic Presentation on the Water Efficiency Label</i>	:  滴水點 <i>Water droplet(s)</i>
用水效益級別 <i>Water Efficiency Grade</i>	: 2
全沖水量 <i>Water Flush Volume (Full)</i>	: 5.4 公升/沖廁 <i>litres/flush</i>
低沖水量 <i>Water Flush Volume (Reduced)</i>	: 3.2 公升/沖廁 <i>litres/flush</i>

簽發日期:
Date of Issue: 22 March 2021

 水務署
Water Supplies Department



水務署署長(張業駒代行)
for Director of Water Supplies

+ 上述水廁具額外節水功能，即：重用洗盥水作沖廁用途。
The above water closet is equipped with additional water saving feature, that is: re-use the water collected from wash basin for flushing purpose.



水務署
Water Supplies Department

總部 Headquarters

香港灣仔告士打道七號入境事務大樓 48 樓

48/F, Immigration Tower, 7 Gloucester Road, Wan Chai, Hong Kong

本署檔號
Our ref.
來函檔號
Your ref.



21/19 Pt.1 T/J(344)

電話
Tel.
傳真
Fax.

:
:
: 2824 0578

9 May 2019



Dear Sir,

**Approval of "NUCA" Float Operated Valve
(General Acceptance No. C20190284F)**

Your letters ref. TFWC-2019-004 and TFWC-2019-004R dated 4 April 2019 and 25 April 2019 respectively refer.

Having considered the test report ref. BC-SUMMARY-2019-17 issued on 24 April 2019 by Castco Testing Centre Limited, this Authority accepts that the fitting described below complies with, and its use when correctly installed does not contravene, the Waterworks Ordinance and Regulations.

Name of Manufacturer: Compas (Xiamen) Plumbing Technology Co Ltd
Country of Origin: the Mainland of China
Brand: NUCA
Details of Fitting: 1/2" Plastic bottom inlet float operated valve
Model: A101
Body Markings: NUCA A101
Expiry Date: 22 April 2024



Proviso: As the fitting has not been tested for use in contact with water intended for human consumption, the fitting can only be used in flushing water plumbing system.

This Authority hereby permits the use of the above fitting in flushing water plumbing systems subject to full adherence to Waterworks installation requirements. In particular, you are required to draw your customers' attention to the following requirement-

"The flushing volume of the flushing valve should be adjusted to suit the design of the toilet bowl so that wastes can be cleared effectively by a single flush."

"The maximum flushing cistern volume including that of dual flush cisterns for use in conjunction with the fittings shall not exceed 7.5 litres per flush."

"The fitting should be used within the range of working pressures specified by the manufacturer." AND

"The installed fitting should not result in backflow of water that will contaminate the flushing water supply."

A condition of this acceptance is that the fitting to be installed shall be replicas of the sample as certified by the testing agent mentioned above and without modifications. This acceptance may be withdrawn at any time if the standard of the fitting installed fails to meet that of the approved sample or if the fitting is found to be unsuitable for use in flushing water plumbing systems.

For the use of the fitting in any project, the General Acceptance Number of this letter must be quoted as a means of identification of acceptance of the fitting by this Authority.

Should you have any enquiries, please contact our Engineer Mr. Terry KUNG at tel. no. 3583 4086.

Yours faithfully,



(CHAN Chung-kun)

for Director of Water Supplies

Encl.

c.c. WSD 3321/1/82] - without catalogue
ME/MC] - with soft copy only



水務署
Water Supplies Department

總部 Headquarters

香港灣仔告士打道七號入境事務大樓 48 樓

48/F, Immigration Tower, 7 Gloucester Road, Wan Chai, Hong Kong

本署檔號
Our ref.
來函檔號
Your ref.



SI 1/2023 T/J(173/2023)

電話

Tel.

傳真

Fax

: 2824 0578

25 April 2023



Dear Sir,

**Approval of “NUCA” Flush Valve
(General Acceptance No. C20230276F)**

Your letters ref. TFWC-2023-004 and TFWC-2023-004R dated 24 February 2023 and 31 March 2023 respectively refer.

Having considered the test report ref. J28641r1 issued on 31 March 2023 by Nutek Systems (HK) Limited, this Authority accepts that the fitting described below complies with, and its use when correctly installed does not contravene, the Waterworks Ordinance and Regulations.

Name of Manufacturer: Compas (Xiamen) Plumbing Technology Co Ltd

Country of Origin: the Mainland of China

Brand: NUCA

Details of Fitting: 2" Plastic dual flush valve

Model: C211

Body Markings: **NUCA**

Expiry Date: 15 June 2027



Proviso: As the fitting has not been tested for use in contact with water intended for human consumption, the fitting can only be used in flushing water plumbing system.

This Authority hereby permits the use of the above fitting in flushing water plumbing systems subject to full adherence to Waterworks installation requirements. In particular, you are required to draw your customers' attention to the following requirement-

"The flushing volume of the flushing valve should be adjusted to suit the design of the toilet bowl so that wastes can be cleared effectively by a single flush."

"The fitting should be used within the range of working pressures specified by the manufacturer." AND

"The installed fitting should not result in backflow of water that will contaminate the flushing water supply."

A condition of this acceptance is that the fitting to be installed shall be replicas of the sample as certified by the testing agent mentioned above and without modifications. This acceptance may be withdrawn at any time if the standard of the fitting installed fails to meet that of the approved sample or if the fitting is found to be unsuitable for use in flushing water plumbing systems.

For the use of the fitting in any project, the General Acceptance Number of this letter must be quoted as a means of identification of acceptance of the fitting by this Authority.

Should you have any enquiries, please contact our Engineer Ms Winnie LO at tel. no. 3583 4086.

Yours faithfully,

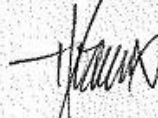

(YAU Hau Yin)

for Director of Water Supplies

Encl.

c.c. WSD 3321/1/82] - without catalogue
ME/MC] - with soft copy only

產品參數

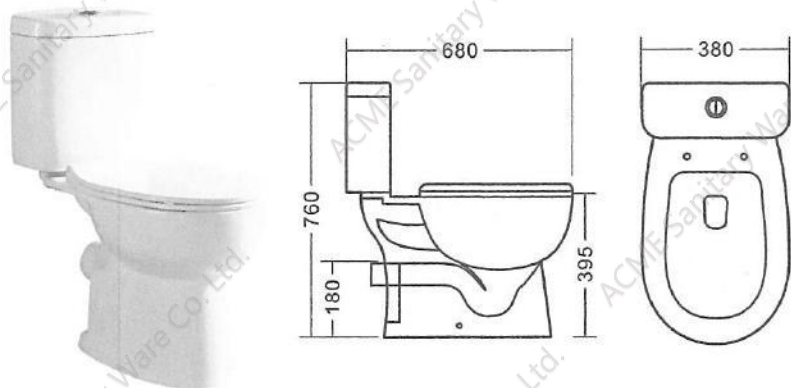

產品品牌: Ansporn

產品型號: WC-8008

產品描述: 分體座便器

產品尺寸: 長度 680mm, 寬度 380mm, 高度 760mm

產品坑距: P-180mm

產品用水量: 3/6升

馬桶配件清單

1. 陶瓷水箱1個
2. 陶瓷馬桶坐頭1個
3. 塑料PP蓋板1套
4. 水件1套 (含膠圈, 按鈕和螺絲)
5. 地腳螺絲配件1套
6. 說明書1份



產品安裝



圖.1

水件安裝在水箱裏



圖.2

鎖住水箱和坐頭

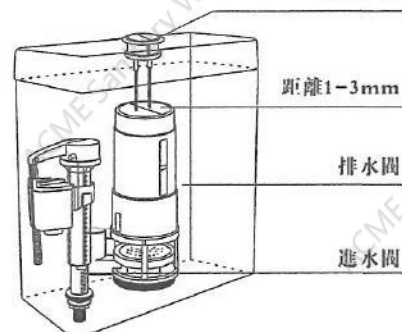

圖.3

把角圍裏的水排出
一分鐘後, 再安裝

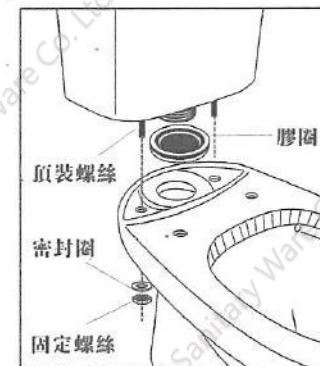

圖.4

測試馬桶, 衝洗幾次,
檢查是否滲漏

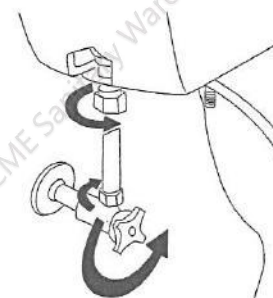

圖.5

安裝水箱蓋和蓋板

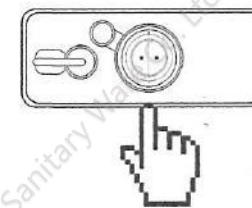
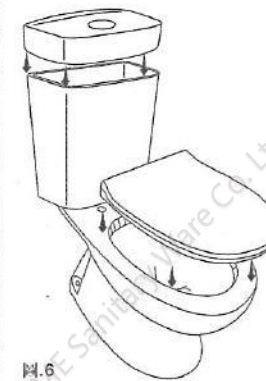

圖.6